

Lever Type Dial Indicators Dial Test Indicators

Small Tool Instruments
and Data Management



Drastically Enhanced Durability, Sensitivity and Visibility

Lever Type Dial Indicator Dial Test Indicator



Improvement in visibility

- Using universal fonts, changing dial face color and reviewing the relationship between pointer and scale marks have drastically improved visibility.

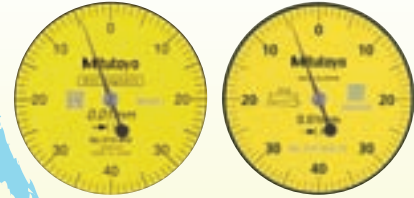

Conventional

New

Crystal for readability

- Glare-free flat crystal face allows easy reading of graduations.



Conventional

New

Preventing dust and oil from penetrating to the dial face

- The O-ring seal on the bezel has the effect of providing smooth rotation and prevents dust and oil from penetrating through to the dial face.

Bonded bezel and crystal

- Bonding the bezel and crystal together leaves no gap for cutting fluid or oil to penetrate through to the dial face.

Preventing bezel detachment

- A flange prevents the bezel from unintentional removal due to applying a force to the bezel during handling.



Conventional

New

Naming of parts

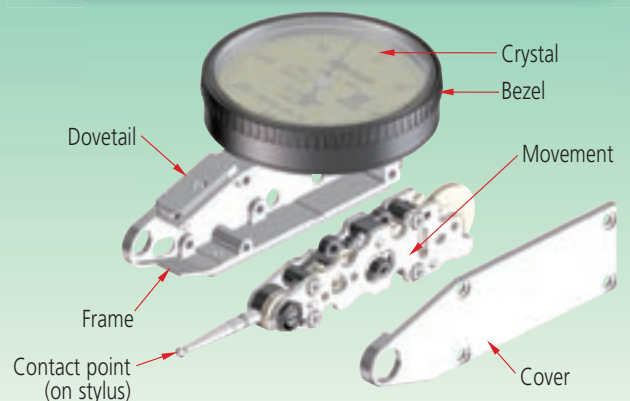

A choice of dial position

Features 1

Our product lineup offers four models, each with a different orientation of the dial on the frame to allow best visibility of the dial face in any specific situation.

- Horizontal type: the standard model - the dial is on top of the frame.
- Vertical type: the model with the dial on the end of the frame.
- Horizontal (20° tilted face) type: the model with the dial on top of the frame but tilted backward at 20°.
- Parallel type: the model with the dial on the side of the frame.

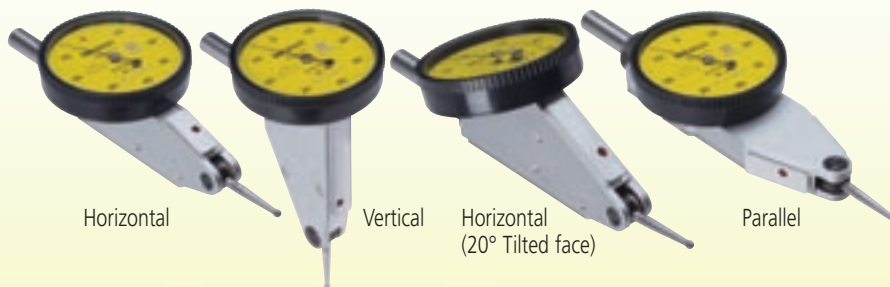

Multi-layer coatings on the crystal

- Hard, antifouling and non-glare coatings on the crystal inhibit scratches, contamination and glare on the surface.

Improved stylus bearing

- The conventional method of mounting the stylus pivot bearing screw in the frame is prone to allowing looseness to develop with prolonged use. A unique sub-plate structure to house this screw has now been incorporated in all models and eliminates this issue.



Stylus bearing screw held in frame.



Stylus bearing screw held in sub-plate.

Maintaining trackability

- The ability of the indicator to track small changes in displacement deteriorates due to minute changes in clearance between the gears with prolonged use. Redesigned mounting for the gears enables the new models to maintain good trackability.

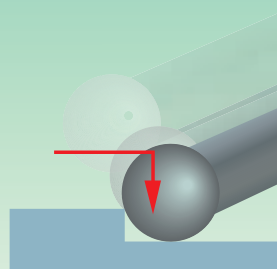

Indicator trackability depends on maintaining gear-train stability

Drastically Enhanced Durability, Sensitivity and Visibility

Lever Type Dial Indicator Dial Test Indicator



Inspection

- The inspection certificate publication system linked to the QR code marked on the dial face allows attachment of an "Inspection Certificate" provided with shipping inspection data. Since the customer's purchase date will not be identified from the QR code, it cannot be used to obtain a "Calibration Certificate".

Stylus length is marked on the dial face

- As the length of the stylus fitted affects the indicator's scale factor the length that gives a scale factor of unity is marked on the dial face to assist a customer when ordering the correct replacement stylus.

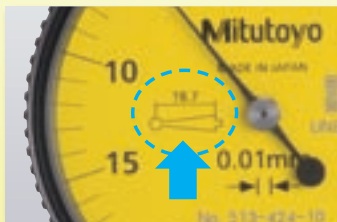

Attachable limit hands

- Limit hands (optional) can be attached to the bezel the same as for dial indicators, allowing easy identification of the upper and lower limits of tolerance.

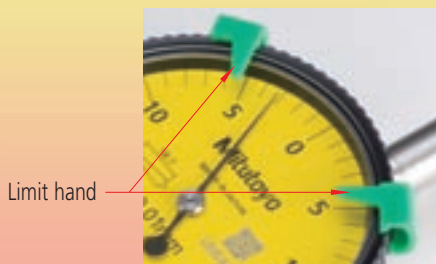

ø8/ø9.52 stem to fit dovetails is a standard accessory

- A ø8mm (ø0.315 in) plain stem (**21CAB104**) for the Metric models or a ø9.52mm (ø3/8 in) plain stem (**21CAB105**) for the Inch models that attaches to any dovetail on the frame is supplied as a standard accessory. Other sizes of stem to fit the dovetails are available as optional accessories:

- ø4mm (ø0.157 in) stem: **21CAB106**
- ø6mm (ø0.236 in) stem: **21CAB103**

certificate attached

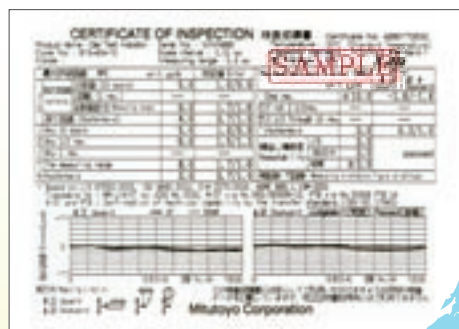

Extended stylus length for 0.001mm, 0.002mm, and 0.0001 in graduation models

- Longer styli have been introduced on the most sensitive indicators to make probing those features of a workpiece that are difficult to access more user-friendly.

0.001mm graduation models: L₂ now 15.2mm, was 11.2mm
 0.002mm graduation models: L₂ now 11.2mm, was 9.4mm
 0.0001 in graduation models: L₂ now 0.61 in, was 0.45 in

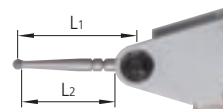

Ruby ball-tipped stylus added to lineup

- A ruby tip has resistance to wear several times greater than a carbide tip and, since it is nonconductive, it can be used with safety even on an electrical discharge machine.

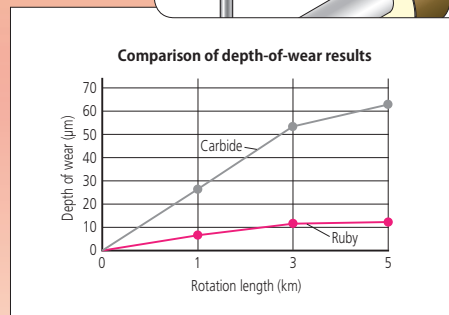
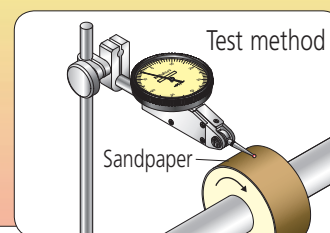



Horizontal (Standard model)

Metric Provides wide variations of models conforms to the required accuracy, range, and surface of workpieces.



513-424-10

Contact point No. 137557



Graduation: 0.01mm
Range: 0.5mm

513-424-10E/513-424-10A/
513-424-10T

- Standard
- Double scale spacing
- Carbide contact point (Anti-magnet)



513-414-10

Contact point No. 131324



Graduation: 0.01mm
Range: 0.5mm

513-414-10E/513-414-10A/
513-414-10T

- Long stylus
- Carbide contact point (Anti-magnet)
- Double scale spacing



513-478-10

Contact point No. 21CZA210



Graduation: 0.01mm
Range: 0.5mm

513-478-10E

- Ruby contact point (non-magnet)
- Standard
- Double scale spacing



513-474-10

Contact point No. 21CZA201



Graduation: 0.01mm
Range: 0.8mm

513-474-10E

- Ruby contact point (non-magnet)
- Standard



513-466-10

Contact point No. 137557



Graduation: 0.01mm
Range: 0.5mm

513-466-10E

- Small face diameter
- Double scale spacing
- Compact
- Carbide contact point (Anti-magnet)



513-464-10

Contact point No. 103006



Graduation: 0.01mm
Range: 0.8mm

513-464-10E

- Small face diameter
- Compact
- Carbide contact point (Anti-magnet)



513-404-10

Contact point No. 103006



Graduation: 0.01mm
Range: 0.8mm

513-404-10E/513-404-10A/
513-404-10T/513-404-10C

- Standard
- Carbide contact point (Anti-magnet)



513-415-10

Contact point No. 136013



Graduation: 0.01mm
Range: 1.0mm

513-415-10E/513-415-10A/
513-415-10T

- Long stylus
- Carbide contact point (Anti-magnet)



513-477-10

Contact point No. 21CZA211



Graduation: 0.01mm
Range: 1.0mm

513-477-10E

- Ruby contact point (non-magnet)
- Long stylus



513-475-10

Contact point No. 21CZB068



Graduation: 0.002mm
Range: 0.2mm

513-475-10E

- Ruby contact point (non-magnet)
- Standard



513-426-10

Contact point No. 137557



Graduation: 0.01mm
Range: 1.5mm

513-426-10E/513-426-10A

- With revolution counter
- Double scale spacing
- Carbide contact point (Anti-magnet)



513-425-10

Contact point No. 103011



Graduation: 0.002mm
Range: 0.6mm

513-425-10E/513-425-10A

- With revolution counter
- Carbide contact point (Anti-magnet)



513-405-10

Contact point No. 103011



Graduation: 0.002mm
Range: 0.2mm

513-405-10E/513-405-10A/
513-405-10T

- Standard
- Carbide contact point (Anti-magnet)



513-465-10

Contact point No. 103011



Graduation: 0.002mm
Range: 0.2mm

513-465-10E

- Small face diameter
- Compact
- Carbide contact point (Anti-magnet)



513-471-10

Contact point No. 21CZA209



Graduation: 0.001mm
Range: 0.14mm

513-471-10E

- Ruby contact point (non-magnet)
- High accuracy



513-401-10

Contact point No. 103010



Graduation: 0.001mm
Range: 0.14mm

513-401-10E

- High accuracy
- Carbide contact point (Anti-magnet)



Horizontal (Standard model)

Inch





513-402-10

Contact point No. 133195



Graduation: 0.0005 in
Range: 0.03 in

513-402-10E/513-402-10T

-  Standard
-  Carbide contact point (Anti-magnet)





513-462-10

Contact point No. 133195



Graduation: 0.0005 in
Range: 0.03 in

513-462-10E

-  Compact
-  Carbide contact point (Anti-magnet)



513-472-10

Contact point No. 21CZA204



Graduation: 0.0005 in
Range: 0.03 in

513-472-10E

-  Standard
-  Ruby contact point (non-magnet)





513-403-10

Contact point No. 21CZB064



Graduation: 0.0001 in
Range: 0.008 in

513-403-10E/513-403-10T

-  Standard
-  Anti-magnet (non-magnet)





513-412-10

Contact point No. 136290



Graduation: 0.0005 in
Range: 0.03 in

513-412-10E/513-412-10T

-  Long stylus
-  Carbide contact point (Anti-magnet)





513-473-10

Contact point No. 21CZB112



Graduation: 0.0001 in
Range: 0.008 in

513-473-10E

-  Standard
-  Ruby contact point (non-magnet)





512-479-10

Contact point No. 21CZA214



Graduation: 0.0005 in
Range: 0.03 in

512-479-10E

-  Long stylus
-  Ruby contact point (non-magnet)





513-463-10

Contact point No. 21CZB064



Graduation: 0.0001 in
Range: 0.008 in

513-463-10E

-  Compact
-  Carbide contact point (Anti-magnet)

Metric/inch



513-409-10

Contact point No. 103011



Graduation: 0.002mm/0.0001 in
Range: 0.2mm/0.0076 in

513-409-10E/513-409-10T

Carbide contact point (Anti-magnet)

Inch/Metric



513-406-10

Contact point No. 133195



Graduation: 0.0005 in/0.01mm
Range: 0.03 in/0.7mm

513-406-10E/513-406-10T

Carbide contact point (Anti-magnet)

DIMENSIONS

Vertical

Unit: mm

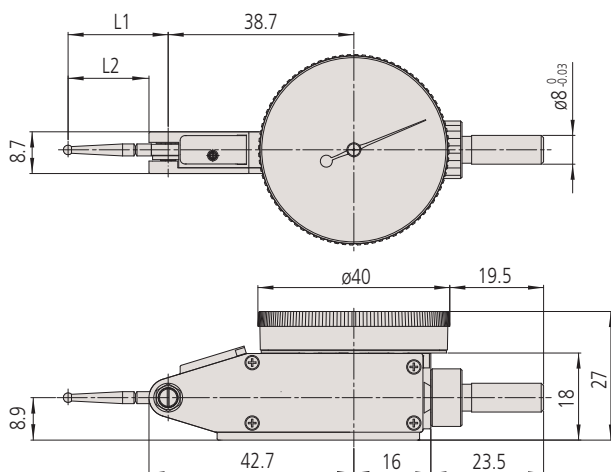

Type	Order No.	L1	L2
Vertical	513-401-10E	14.7	11.2
	513-471-10E		
	513-405-10E/A/T	18.7	15.2
	513-415-10E/A		
	513-475-10E		
	513-404-10E/A/T	20.9	17.4
	513-474-10E		
	513-424-10E/A/T	22.2	18.7
	513-426-10E/A		
	513-478-10E		
	513-414-10E/A/T	37.4	33.9
	513-415-10E/A/T	44.5	41.0
513-477-10E			

Compact

Unit: mm

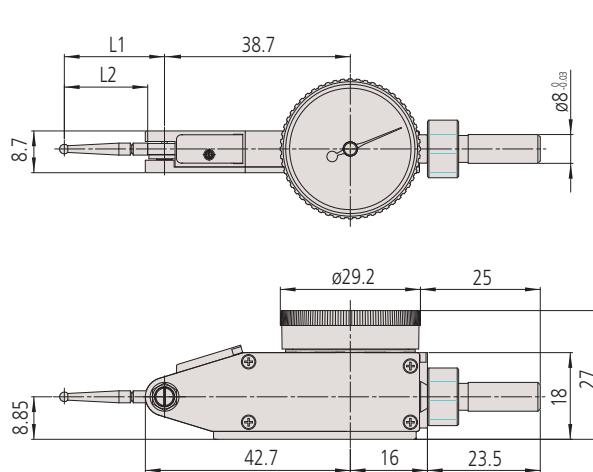

Type	Order No.	L1	L2
Compact	513-465-10E	18.7	15.2
	513-464-10E	20.9	17.4
	513-466-10E	22.2	18.7



Horizontal (Standard model)

SPECIFICATIONS

Order No.			Graduation	Range	Dial reading	Indication accuracy			Mass	Measuring force	High accuracy	With revolution counter	Long stylus	Standard	Double scale spacing	Compact	Carbide contact point (Anti-magnet)	Ruby contact point (non-magnet)									
Basic set	Plus set	Full set				Measuring range	10 scale divisions	Hysteresis											Repetability								
513-424-10E	513-424-10A	513-424-10T	0.01 mm	0.5 mm	0-25-0	6 μm	5 μm	4 μm	3 μm	45g	0.3N or less																
513-478-10E	-	-				6 μm		4 μm											41g	0.3N or less							
513-466-10E	-	-		0.8 mm	0-40-0	9 μm		2 μm		4 μm	1 μm	45g	0.2N or less														
513-404-10E	513-404-10A	513-404-10T																				9 μm	5 μm	45g	0.2N or less		
513-414-10E	513-414-10A	513-414-10T		0.5 mm	0-25-0	10 μm				2 μm		4 μm	1 μm	45g	0.3N or less												
513-474-10E	-	-																						9 μm	5 μm	41g	0.3N or less
513-464-10E	-	-		1.0 mm	0-40-0	10 μm						2 μm		4 μm	1 μm	45g	0.2N or less										
513-415-10E	513-415-10A	513-415-10T																								10 μm	5 μm
513-477-10E	-	-		1.5 mm	0-25-0	16 μm								2 μm		4 μm	1 μm	45g	0.4N or less								
513-426-10E	513-426-10A	-																									
543-405-10E	543-405-10A	543-405-10T	0.002 mm	0.2 mm	0-100-0	2 μm	4 μm		1 μm							45g		0.3N or less									
513-471-10E	-	-	0.001 mm	0.14 mm	0-70-0																					4 μm	3 μm
513-475-10E	-	-	0.002 mm	0.6 mm	0-100-0		2 μm	7 μm			1 μm					45g		0.4N or less									
513-425-10E	513-425-10A	-																									0.2 mm
513-465-10E	-	-	0.001 mm	0.14 mm	0-70-0			2 μm		4 μm			1 μm			45g		0.3N or less									
513-401-10E	-	-																									4 μm

Order No.			Graduation	Range	Dial reading	Indication accuracy			Mass	Measuring force	High accuracy	With revolution counter	Long stylus	Standard	Double scale spacing	Compact	Carbide contact point (Anti-magnet)	Ruby contact point (non-magnet)															
Basic set	Plus set	Full set				One rev.	Hysteresis	Repetability																									
513-402-10E	-	513-402-10T	0.0005 in	0.03 in	0-15-0	±0.0005 in	0.0002 in	0.0002 in	45g	0.3N or less																							
513-472-10E	-	-																	0.2N or less														
513-412-10E	-	513-412-10T								0.0001 in	0.008 in	0-4-0	±0.0001 in	0.0001 in	0.00004 in	45g	0.3N or less																
513-479-10E	-	-																							41g								
513-462-10E	-	-	0.0001 in	0.008 in	0-4-0	±0.0001 in	0.0001 in	0.00004 in	45g	0.3N or less																							
513-403-10E	-	513-403-10T																	41g														
513-473-10E	-	-																	41g														
513-463-10E	-	-																															

Order No.			Graduation	Range	Dial reading	Indication accuracy			Mass	Measuring force	High accuracy	With revolution counter	Long stylus	Standard	Double scale spacing	Compact	Carbide contact point (Anti-magnet)	Ruby contact point (non-magnet)
Basic set	Plus set	Full set				Measuring range	10 scale divisions	Hysteresis										
513-409-10E	-	513-409-10T	0.002mm / 0.0001 in	0.2mm / 0.0076 in	0-10-0 / 0-38-0	4μm	2μm	3μm	1μm	45g	0.3N or less							

Order No.			Graduation	Range	Dial reading	Indication accuracy			Mass	Measuring force	High accuracy	With revolution counter	Long stylus	Standard	Double scale spacing	Compact	Carbide contact point (Anti-magnet)	Ruby contact point (non-magnet)
Basic set	Plus set	Full set				Measuring range	Hysteresis	Repetability										
513-406-10E	-	513-406-10T	0.0005 in / 0.01mm	0.03 in / 0.7mm	0-15-0 / 0-35-0	±0.0005 in	0.0002 in	0.0002 in	45g	0.3N or less								

* Stem with ø6 dovetail groove is not included in the mass.

* Be sure to perform calibration with reference gage, etc. after exchanging the contact point. The inside parts may be damaged when the contact point is exchanged due to the breakage. In the case the of the significant deterioration in the operation, repair is required.



Parallel (The scale can be read from the front, with the contact point pivoting in a plane parallel to that of the dial face)

Metric

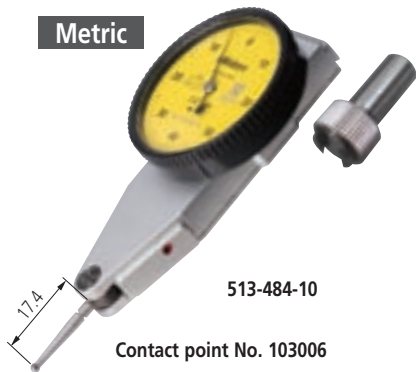

Graduation: 0.01mm
Range: 0.8mm

**513-484-10E/513-484-10A/
513-484-10T**

Carbide contact point (Anti-magnet)



Graduation: 0.01mm
Range: 0.5mm

513-486-10E

Double scale spacing
 Carbide contact point (Anti-magnet)



Graduation: 0.002mm
Range: 0.2mm

513-485-10E

Carbide contact point (Anti-magnet)



Graduation: 0.0005 in
Range: 0.03 in

513-482-10A/513-482-10T

Carbide contact point (Anti-magnet)

SPECIFICATIONS

Metric

Order No.			Graduation	Range	Dial reading	Indication accuracy				Mass	Measuring force	High accuracy	With revolution counter	Long stylus	Standard	Double scale spacing	Compact	Carbide contact point (Anti-magnet)	Ruby contact point (non-magnet)	
Basic set	Plus set	Full set				Measuring range	10 scale divisions	Hysteresis	Repeatability											
513-484-10E	513-484-10A	513-484-10T	0.01mm	0.8mm	0-40-0	9µm	5µm	4µm	3µm	53g	0.3N or less	<input checked="" type="checkbox"/>	<input checked="" type="checkbox"/>	<input type="checkbox"/>	<input type="checkbox"/>	<input type="checkbox"/>	<input type="checkbox"/>	<input checked="" type="checkbox"/>	<input type="checkbox"/>	
513-485-10E	-	-	0.002mm	0.2mm	0-100-0	4µm	2µm	3µm	1µm			<input type="checkbox"/>	<input type="checkbox"/>	<input type="checkbox"/>	<input type="checkbox"/>	<input type="checkbox"/>	<input type="checkbox"/>	<input type="checkbox"/>	<input checked="" type="checkbox"/>	<input type="checkbox"/>
513-486-10E	-	-	0.01mm	0.5mm	0-25-0	6µm	5µm	4µm	3µm			<input type="checkbox"/>	<input type="checkbox"/>	<input type="checkbox"/>	<input type="checkbox"/>	<input checked="" type="checkbox"/>	<input type="checkbox"/>	<input checked="" type="checkbox"/>	<input type="checkbox"/>	<input type="checkbox"/>

Inch

Order No.			Graduation	Range	Dial reading	Indication accuracy			Mass	Measuring force	High accuracy	With revolution counter	Long stylus	Standard	Double scale spacing	Compact	Carbide contact point (Anti-magnet)	Ruby contact point (non-magnet)
Basic set	Plus set	Full set				Measuring range	Hysteresis	Repeatability										
-	513-482-10A	513-482-10T	0.0005 in	0.03 in	0-15-0	±0.0005 in	0.0002 in	0.0002 in	53g	0.3N or less	<input checked="" type="checkbox"/>	<input checked="" type="checkbox"/>	<input type="checkbox"/>	<input type="checkbox"/>	<input type="checkbox"/>	<input type="checkbox"/>	<input checked="" type="checkbox"/>	<input type="checkbox"/>

* Stem with ø6 dovetail groove is not included in the mass.

* Be sure to perform calibration with reference gage, etc. after exchanging the contact point. The inside parts may be damaged when the contact point is exchanged due to the breakage. In the case of the significant deterioration in the operation, repair is required.

DIMENSIONS

* No dovetail in the back.

Unit: mm

Order No.	L1	L2
513-484-10E	20.9	17.4
513-485-10E	18.7	15.2
513-486-10E	22.2	18.7



Vertical (Best suited for centering holes under the spindle of a machine tool)

Metric



Graduation: 0.01mm
Range: 0.8mm

513-454-10E/513-454-10A/
513-454-10T

Carbide contact point (Anti-magnet)



Graduation: 0.002mm
Range: 0.2mm

513-455-10E/513-455-10A/
513-455-10T

Carbide contact point (Anti-magnet)



Graduation: 0.01mm
Range: 0.5mm

513-456-10E

Double scale spacing

Carbide contact point (Anti-magnet)

Inch



Graduation: 0.0005 in
Range: 0.03 in

513-452-10E/513-452-10T

Carbide contact point (Anti-magnet)



Graduation: 0.0001 in
Range: 0.008 in

513-453-10E/513-453-10T

Carbide contact point (Anti-magnet)

SPECIFICATIONS

Metric																					
Order No.			Graduation	Range	Dial reading	Indication accuracy				Mass	Measuring force	High accuracy	With revolution counter	Long stylus	Standard	Double scale spacing	Compact	Carbide contact point (Anti-magnet)	Ruby contact point (non-magnet)		
Basic set	Plus set	Full set				Measuring range	10 scale divisions	Hysteresis	Repetability												
513-454-10E	513-454-10A	513-454-10T	0.01mm	0.8mm	0-40-0	9μm	5μm	4μm	3μm	46g	0.3N or less	<input checked="" type="checkbox"/>	<input checked="" type="checkbox"/>	<input checked="" type="checkbox"/>	<input checked="" type="checkbox"/>	<input checked="" type="checkbox"/>	<input checked="" type="checkbox"/>	<input checked="" type="checkbox"/>	<input checked="" type="checkbox"/>		
513-455-10E	513-455-10A	513-455-10T	0.002mm	0.2mm	0-100-0	4μm	2μm	3μm	1μm			<input type="checkbox"/>	<input type="checkbox"/>	<input type="checkbox"/>	<input type="checkbox"/>	<input type="checkbox"/>	<input type="checkbox"/>	<input type="checkbox"/>	<input type="checkbox"/>	<input type="checkbox"/>	<input type="checkbox"/>
513-456-10E	-	-	0.01mm	0.5mm	0-25-0	6μm	5μm	4μm	3μm			<input type="checkbox"/>	<input type="checkbox"/>	<input type="checkbox"/>	<input type="checkbox"/>	<input checked="" type="checkbox"/>	<input type="checkbox"/>	<input type="checkbox"/>	<input checked="" type="checkbox"/>	<input type="checkbox"/>	

Inch																		
Order No.			Graduation	Range	Dial reading	Indication accuracy			Mass	Measuring force	High accuracy	With revolution counter	Long stylus	Standard	Double scale spacing	Compact	Carbide contact point (Anti-magnet)	Ruby contact point (non-magnet)
Basic set	Plus set	Full set				Measuring range	Hysteresis	Repetability										
513-452-10E	-	513-452-10T	0.0005 in	0.03 in	0-15-0	±0.0005 in	0.0002 in	0.0002 in	46g	0.3N or less	<input checked="" type="checkbox"/>	<input checked="" type="checkbox"/>	<input checked="" type="checkbox"/>	<input checked="" type="checkbox"/>	<input checked="" type="checkbox"/>	<input checked="" type="checkbox"/>	<input checked="" type="checkbox"/>	<input checked="" type="checkbox"/>
513-453-10E	-	513-453-10T	0.0001 in	0.008 in	0-4-0	±0.0001 in	0.0001 in	0.00004 in			<input type="checkbox"/>	<input type="checkbox"/>	<input type="checkbox"/>	<input type="checkbox"/>	<input type="checkbox"/>	<input type="checkbox"/>	<input type="checkbox"/>	<input type="checkbox"/>

* Stem with ø6 dovetail groove is not included in the mass.

* Be sure to perform calibration with reference gage, etc. after exchanging the contact point. The inside parts may be damaged when the contact point is exchanged due to the breakage. In the case the of the significant deterioration in the operation, repair is required.

DIMENSIONS

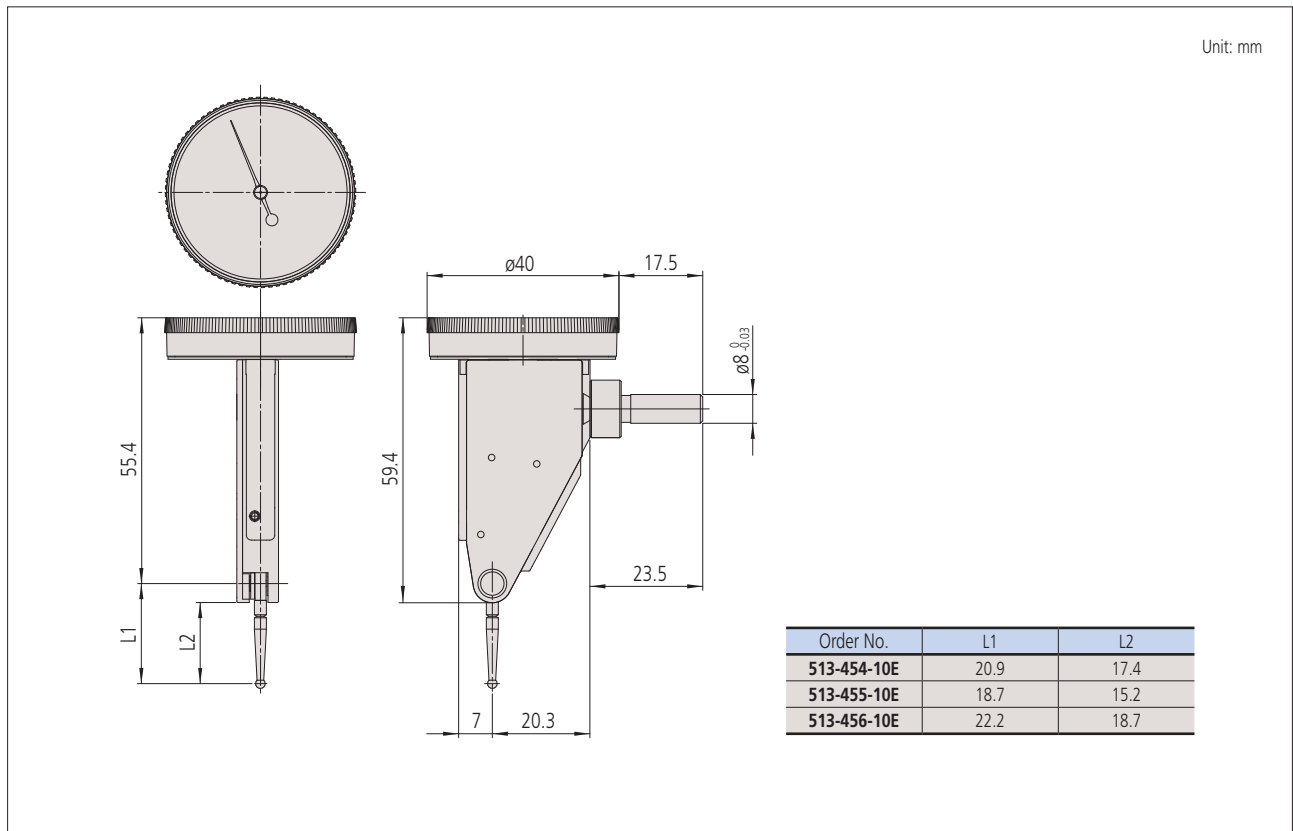



Horizontal (20° Tilted Face) (Dial face inclined 20°, compared with the vertical type, allows easy reading)

Metric



Graduation: 0.01mm
Range: 1.6mm

513-444-10E/513-444-10A/
513-444-10T

- With revolution counter
- Carbide contact point (Anti-magnet)



Graduation: 0.02mm
Range: 0.4mm

513-445-10E/513-445-10A/
513-445-10T

- With revolution counter
- Carbide contact point (Anti-magnet)

Inch



Graduation: 0.0005 in
Range: 0.06 in

513-442-10A/513-442-10T

- With revolution counter
- Carbide contact point (Anti-magnet)



Graduation: 0.0005 in
Range: 0.06 in

513-442-16A/513-442-16T

- With revolution counter
- Carbide contact point (Anti-magnet)



Graduation: 0.0005 in
Range: 0.06 in

513-446-10A/513-446-10T

- With revolution counter
- Long stylus
- Carbide contact point (Anti-magnet)



Graduation: 0.0005 in
Range: 0.06 in

513-446-16A/513-446-16T

- With revolution counter
- Long stylus
- Carbide contact point (Anti-magnet)



Graduation: 0.0001 in
Range: 0.016 in

513-443-10A/513-443-10T

- With revolution counter
- Carbide contact point (Anti-magnet)



Graduation: 0.0001 in
Range: 0.016 in

513-443-16A/513-443-16T

- With revolution counter
- Carbide contact point (Anti-magnet)

SPECIFICATIONS

Order No.			Graduation	Range	Dial reading	Indication accuracy				Mass	Measuring force	High accuracy	With revolution counter	Long stylus	Standard	Double scale spacing	Compact	Carbide contact point (Anti-magnet)	Ruby contact point (non-magnet)
Basic set	Plus set	Full set				Measuring range	10 scale divisions	Hysteresis	Repetability										
513-444-10E	513-444-10A	513-444-10T	0.01mm	1.6mm	0-40-0	16μm	5μm	5μm	3μm	48g	0.3N or less	<input checked="" type="checkbox"/>	<input checked="" type="checkbox"/>	<input type="checkbox"/>	<input type="checkbox"/>	<input type="checkbox"/>	<input type="checkbox"/>	<input checked="" type="checkbox"/>	<input type="checkbox"/>
513-445-10E	513-445-10A	513-445-10T	0.002mm	0.4mm	0-100-0	6μm	2μm	4μm	1μm			<input checked="" type="checkbox"/>	<input type="checkbox"/>	<input type="checkbox"/>	<input type="checkbox"/>	<input type="checkbox"/>	<input type="checkbox"/>	<input type="checkbox"/>	<input checked="" type="checkbox"/>

Order No.			Graduation	Range	Dial reading	Indication accuracy			Mass	Measuring force	High accuracy	With revolution counter	Long stylus	Standard	Double scale spacing	Compact	Carbide contact point (Anti-magnet)	Ruby contact point (non-magnet)
Basic set	Plus set	Full set				Measuring range	Hysteresis	Repetability										
-	513-442-10A	513-442-10T	0.0005 in	0.06 in	0-15-0	±0.0005 in	0.0002 in	0.0002 in	48g	0.3N or less	<input checked="" type="checkbox"/>	<input type="checkbox"/>	<input type="checkbox"/>	<input type="checkbox"/>	<input type="checkbox"/>	<input type="checkbox"/>	<input checked="" type="checkbox"/>	<input type="checkbox"/>
-	513-442-16A	513-442-16T								0.2N or less	<input checked="" type="checkbox"/>	<input checked="" type="checkbox"/>	<input type="checkbox"/>	<input type="checkbox"/>	<input type="checkbox"/>	<input checked="" type="checkbox"/>	<input type="checkbox"/>	
-	513-446-10A	513-446-10T								0.2N or less	<input checked="" type="checkbox"/>	<input checked="" type="checkbox"/>	<input type="checkbox"/>	<input type="checkbox"/>	<input checked="" type="checkbox"/>	<input type="checkbox"/>	<input type="checkbox"/>	
-	513-446-16A	513-446-16T	0.3N or less	<input checked="" type="checkbox"/>	<input type="checkbox"/>	<input type="checkbox"/>	<input type="checkbox"/>	<input checked="" type="checkbox"/>		<input type="checkbox"/>	<input type="checkbox"/>							
-	513-443-10A	513-443-10T	0.0001 in	0.016 in	0-4-0	±0.0002 in	0.0001 in	0.00004 in		0.3N or less	<input checked="" type="checkbox"/>	<input type="checkbox"/>	<input type="checkbox"/>	<input type="checkbox"/>	<input type="checkbox"/>	<input type="checkbox"/>	<input checked="" type="checkbox"/>	<input type="checkbox"/>
-	513-443-16A	513-443-16T								<input checked="" type="checkbox"/>	<input type="checkbox"/>	<input type="checkbox"/>	<input type="checkbox"/>	<input checked="" type="checkbox"/>	<input type="checkbox"/>	<input type="checkbox"/>		

* Stem with ø6 dovetail groove is not included in the mass.

* Be sure to perform calibration with reference gage, etc. after exchanging the contact point. The inside parts may be damaged when the contact point is exchanged due to the breakage. In the case of the significant deterioration in the operation, repair is required.

DIMENSIONS

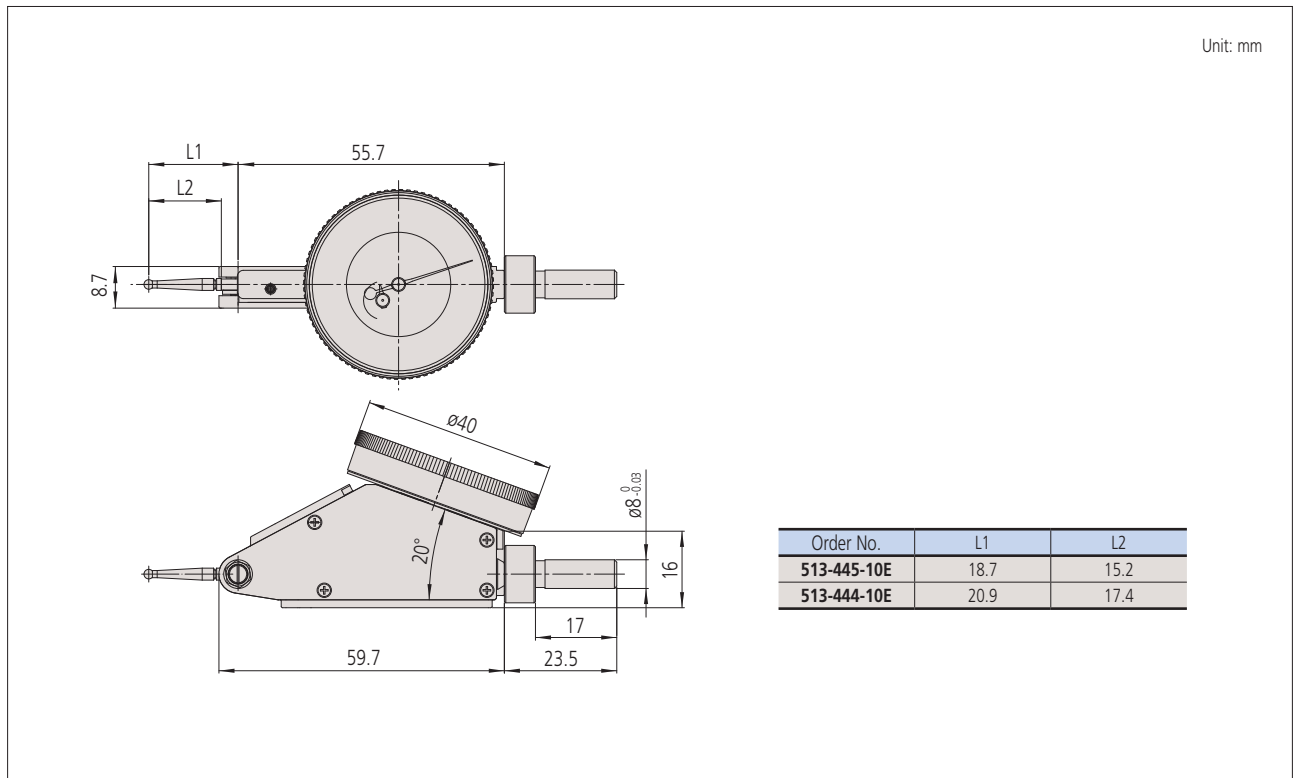

Refer to MEASURING INSTRUMENTS CATALOG No. E2016 for the accessories such as styli, stems with dovetail, holding bars, etc.

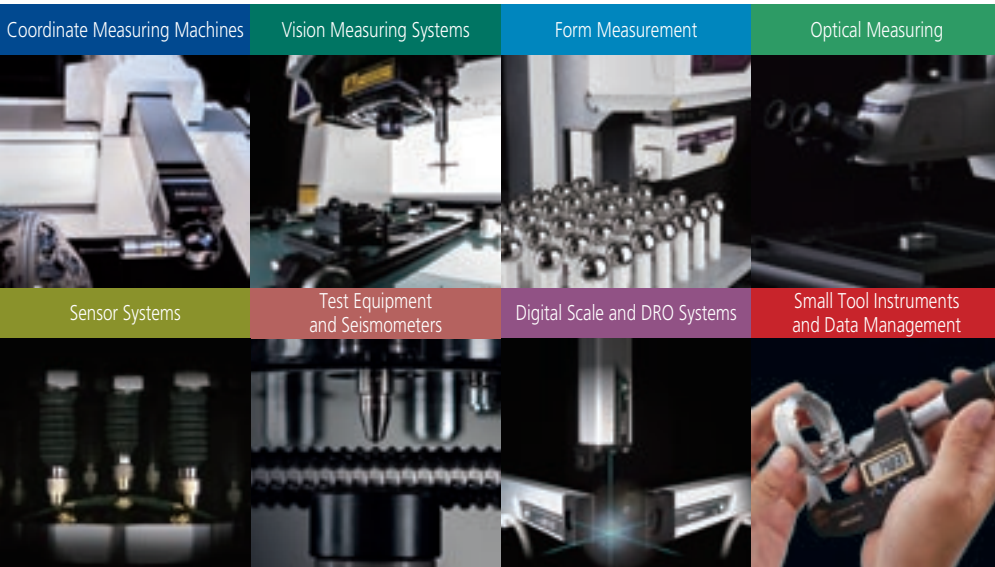

Whatever your challenges are, Mitutoyo supports you from start to finish.

Mitutoyo is not only a manufacturer of top quality measuring products but one that also offers qualified support for the lifetime of the equipment, backed up by comprehensive services that ensure your staff can make the very best use of the investment.

Apart from the basics of calibration and repair, Mitutoyo offers product and metrology training, as well as IT support for the sophisticated software used in modern measuring technology. We can also design, build, test and deliver bespoke measuring solutions and even, if deemed cost-effective, take your critical measurement challenges in-house on a sub-contract basis.



Find additional product literature and our product catalogue

<http://www.mitutoyo.co.jp/global.html>

Note: Product illustrations are without obligation. Product descriptions, in particular any and all technical specifications, are only binding when explicitly agreed upon.
MITUTOYO and MICAT are either registered trademarks or trademarks of Mitutoyo Corp. in Japan and/or other countries/regions. Other product, company and brand names mentioned herein are for identification purposes only and may be the trademarks of their respective holders.

Mitutoyo

Mitutoyo Corporation

20-1, Sakado 1-Chome,
Takatsu-ku, Kawasaki-shi,
Kanagawa 213-8533, Japan
T +81 (0) 44 813-8230
F +81 (0) 44 813-8231
<http://www.mitutoyo.co.jp>